

2232
ÖZEL PROFİL
1.595 kg/mt

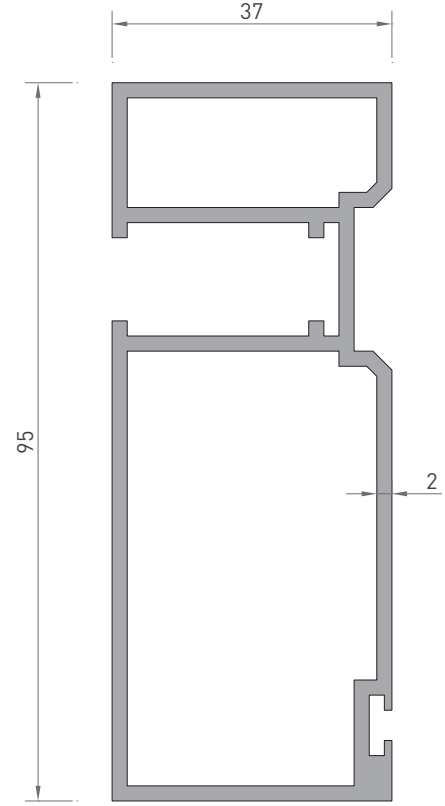

2233
ÖZEL PROFİL
1.755 kg/mt

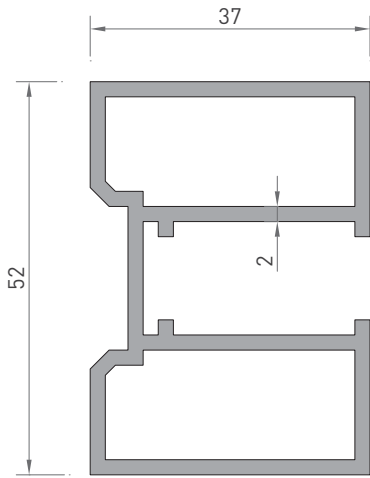

2234
ÖZEL PROFİL
1.230 kg/mt

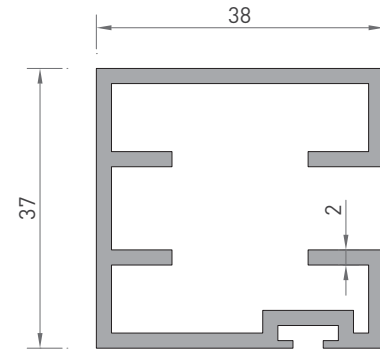

2236
ÖZEL PROFİL
0.925 kg/mt

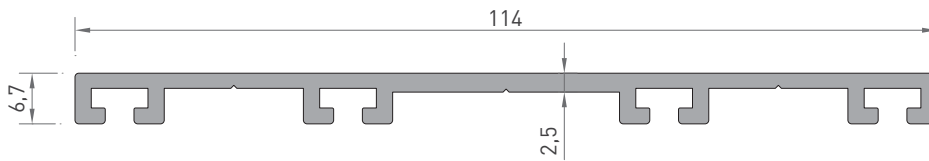

4600
KAPAK CONTA
PROFİL
0.960 kg/mt

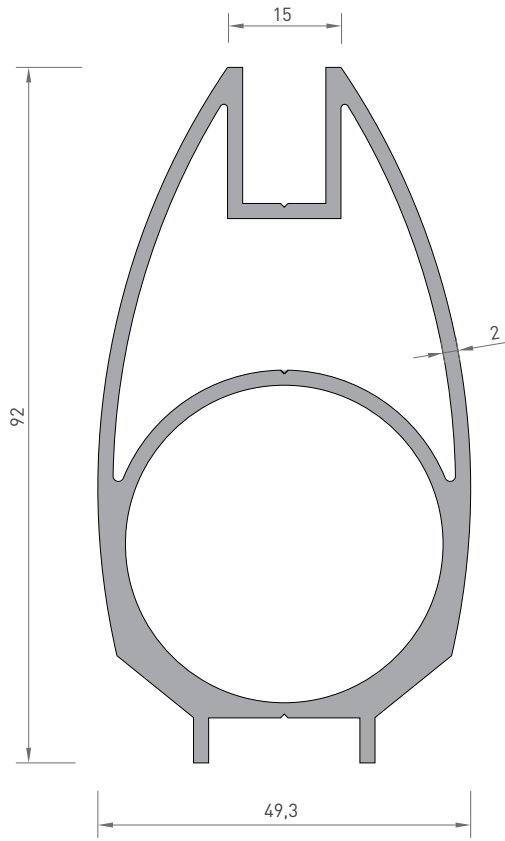
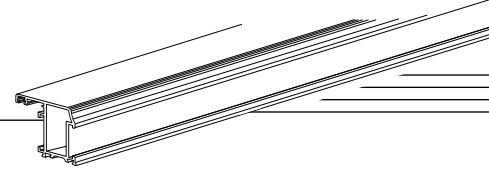

2231
ÖZEL PROFİL
2.185 kg/m

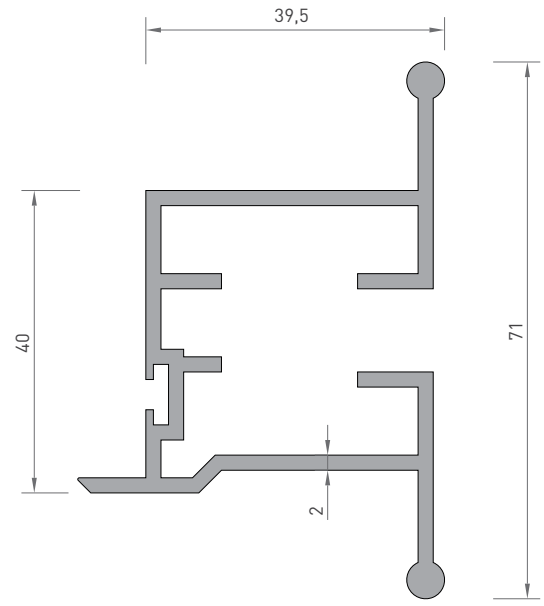

2235
ÖZEL PROFİL
1.320 kg/m

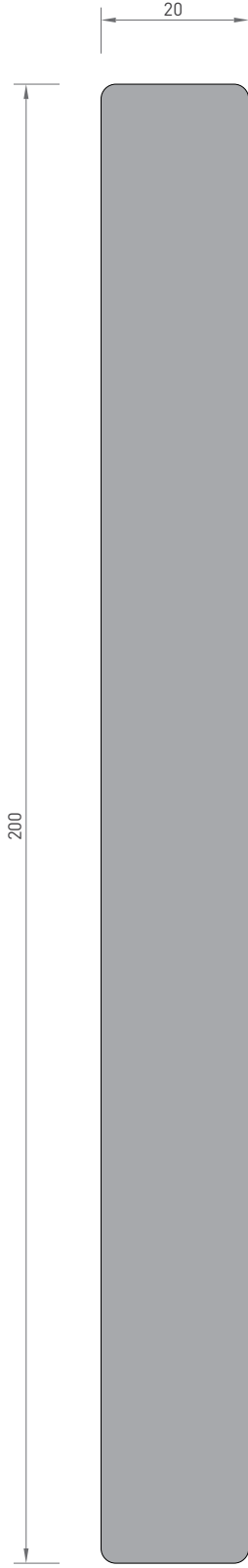

2898
I BARA
10.830 kg/mt

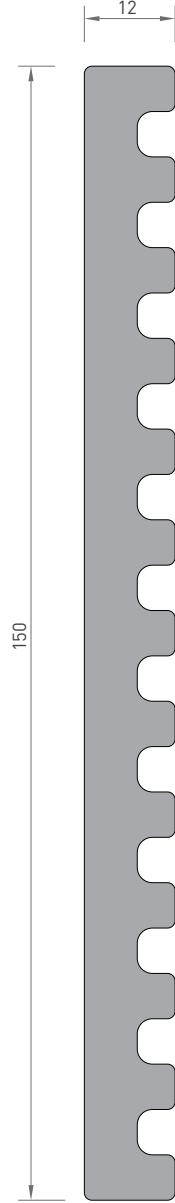

2899
ÇENTİKLİ BARA
3.940 kg/mt

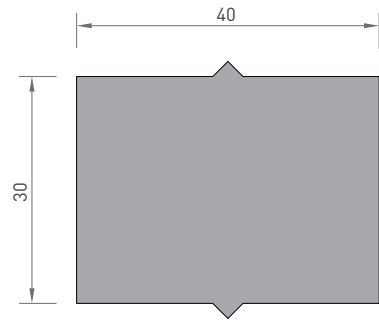

4640
ELOKSAL BARA
3.275 kg/mt

* Belirtilen ağırlıklar Pres Profil için teorik kilogramlardır.
* Boyalı Profillerde ağırlığa % 5 ilave edilmesi gereklidir.